



WASSERMANN
DENTAL-MASCHINEN

● Die Basis für Ihr Labor

● Polishing motor
WSM-2



● SERVICE MANUAL



WASSERMANN DENTAL-MASCHINEN GMBH

Dear customer,

Thank you for choosing a product from the Wassermann range. Wassermann Dental-Maschinen incorporates the highest standards of quality and the latest technology.

In order to enjoy maximum performance and years of trouble-free operation, please read this service manual carefully before you connect this device and start work, and operate the device according to the recommended guidelines. The operation safety and the functionality of this device can only be guaranteed if you follow both the general safety guidelines and the applying laws to prevent accidents as well as the precautions given in this service manual. We are not liable for any damages which occur due to inappropriate usage or faulty operation of this device.



Make sure that anyone using this device has read and understood this service manual.

Keep this service manual in a safe place where it can be referred to as required at any time.

Company address:

Wassermann Dental-Maschinen GmbH

Rudorffweg 15-17

D-21031 Hamburg, Germany

Phone. : +49 (0)40 / 730 926 – 0 Fax.: +49 (0)40 / 730 37 24

E-mail: info@wassermann-dental.com

URL: <http://www.wassermann-dental.com>

Contents

1 Features.....	4
2 Safety guidelines.....	4
2.1 Safety symbols used in this manual.....	4
2.2 Safety guidelines.....	5
2.3 Responsibility for operation or damage.....	5
3 Application.....	5
4 Before starting.....	6
4.1 Transport.....	6
4.2 Installation.....	6
4.3 Storage.....	6
5 Installation / Start-up	7
5.1 Installing the brush spindles.....	7
6 Operation.....	7
6.1 General operating instructions.....	7
7 Troubleshooting.....	8
8 Care and maintenance.....	8
8.1 Cleaning.....	8
8.2 Maintenance.....	9
8.3 Repairs.....	9
8.4 Spare parts.....	9
8.5 Scope of delivery / Accessories.....	9
8.6 Warranty	10
9 Technical data.....	10
10 EC Conformity Certificate.....	11
11 Spare part diagram.....	12
12 Wiring diagram.....	13

1 Features

For metals and plastics: If you're looking for a compact, powerful and especially robust polishing motor, you can't escape the Wassermann WSM-2. It combines years of experience and technical progress in a polishing motor designed for long life and daily use. For grinding, polishing, roughening, cleaning or brushing – fast and clean. And safe!

- compact polishing motor with numerous usage options
- powerful motor, 500 W
- two speeds: 1500 min⁻¹ resp. 3000 min⁻¹
- extremely low-noise thanks to permanently lubricated ball bearing
- control lever with ball-knob– easy to operate, even with the ball of the thumb
- start-up from zero without any problems, smooth run-down
- very stable, no mounting necessary
- perfect power, even in continuous operation
- robust plastic powder coating
- optional connector available
- maintenance-free for life

2 Safety guidelines

2.1 Safety symbols used in this manual



Warning!

This is a warning of risk situations and dangers.

Failure to observe this warning could be life-threatening. These warnings has to be observed.



Information!

This symbol draws your attention to specific features that has to be observed.

2.2 Safety guidelines

Configuring and operating this equipment requires **precise knowledge** and **observance** of the instructions in this **service manual**. The equipment is designed only for its intended application.



WARNING:

Servicing and repairs should be carried out only by authorised specialists.



Make sure that the equipment is connected to the correct power source.

2.3 Responsibility for operation or damage

The responsibility for operating the device lies exclusively with the owner or user if said device is incorrectly serviced, maintained or altered by persons not employed by an authorised dealer or if the device is used in a manner contrary to its specified purpose.

The unit has to be maintained and operated in accordance with this service manual. Wassermann Dental-Maschinen GmbH is not responsible for damage arising from the **nonobservance** of these instructions.

Warranty and responsibility provisions contained in the sales and supply conditions of Wassermann Dental-Maschinen GmbH are not extended by these instructions.

3 Application

The WSM-2 polishing motor is a well-proven, efficient and maintenance-free single-phase AC motor (induction motor) with 2 speed options: 1500 rpm and 3000 rpm. It is fitted with low-noise, completely maintenance-free ball bearings. Shaft ends have 9 mm standard tapers for mounting the brush spindles.

Your polishing motor is designed for polishing dental products. The nuts on each side are used for undoing the polishing spindle and as a form of shaft protection.

Only use the device for this type of application.

4 Before starting

4.1 Transport

Before transporting the unit, ensure that it has been unplugged from the power socket. Make sure that it is packed correctly in order to avoid accidental damage.

 Be sure to check for any transport damage when unpacking the goods. Note down any damage if found.

4.2 Installation

Open the box, remove the packing materials, and carefully lift out the device and accessories. Check the included accessories.

The device has to stand horizontally on a steady and even surface.

The location of your polishing motor is very important for its operational reliability, even if it is only to be stored there for a short time. The room should be dry, well ventilated and vibration-free. An even temperature and wooden base are desirable.

 Install the device in a place where it will not block the working area and the functionality (take the dimensions into account).

 Do not install the unit outdoors or in places without proper ventilation.

Before start-up, be sure the device reaches room temperature.

4.3 Storage

If the unit is to be stored for an extended period, protect it from moisture and dust.

5 Installation / Start-up



Before starting the unit, connect up the following:

5.1 Installing the brush spindles

To use the polishing motor, you have to install the brush spindles, and that involves first removing the nuts. Use a cloth to clean the shaft ends and then replace the nuts.

Use compressed air to remove dust and grime from the brush spindles, then install the spindles as marked: **L = left and R = right**. Use a hammer and a piece of plastic to tap the spindles onto the end of the taper.

Excessive force could damage the ball bearings and void the warranty.

The spindles must run true when the motor is on. If they do not, repeat the above steps.

Finally, insert the power plug into the socket, making sure that the mains and the unit operate on the same voltage.

6 Operation

6.1 General operating instructions



All instructions for using the unit, whether in verbal or written form, are based on our own experience and experimentation and can only be regarded as guidelines.

1. Connect the polishing motor to the mains.
2. Use the toggle switch to select the speed.

7 Troubleshooting

Fault	Cause	Remedy
Ball bearing noise	Faulty bearings	Change bearings
Spindles slip	Spindles too loose	Tap spindles lightly with a hammer
Spindles can not be undone	Spindles too tight on taper	Contact Service



If the above recommendations do not solve the problem, contact your dental depot or our service department.

8 Care and maintenance

8.1 Cleaning



Disconnect the power plug before starting any maintenance work.

The identification plate has always to be kept in easily legible condition and has not to be removed.



Remove external dirt from time to time with some form of cold cleaner.

Use only cold cleaners to avoid damaging the paintwork or removing the lettering.

The equipment should be cleaned at regular intervals to ensure trouble-free operation.

It requires only normal cleaning (sponge, damp cloth, mild detergent) and no further chemical additives.

You should make sure that the bores of the nuts for the brush spindle stay clean. Be especially careful when polishing with pumice.

When undoing the nuts, remember that the **left side has a right-handed thread** and the **right side a left-handed thread**.

8.2 Maintenance

The unit does not require any servicing. Just make sure that the device is kept clean.

8.3 Repairs



Servicing or repairs to the unit has only to be carried out by qualified technicians.

Only original spare parts are to be used. Responsibility for the product is voided if unauthorised persons alter it or if inappropriate components are installed.

8.4 Spare parts

If necessary please contact our service hotline phone:

0049 (0)40 / 730 92 6-0

8.5 Scope of delivery / Accessories

Incl. in delivery	Item no.:
Brush spindle right	152022
Brush spindle left	152025

Accessories	Item no.:
Brush spindle 25 mm right	152022
Brush spindle 125 mm left	152025
Brush spindle 125 mm right	152043
Brush spindle 125 mm left	152044
Stone holder right	152056
Stone holder left	152057
Drill chuck right 1–6 mm clamping	152049
Polishing trough without extractor nozzle	143140
Polishing trough with extractor nozzle (Ø 75 mm)	143130
Extraction traverse for polishing troughs, with aerial frog (output nozzle Ø 75 mm)	143500

8.6 Warranty

 The warranty period for our equipment is 12 months. If faults occur within the warranty period, contact your dental depot or get in touch directly with our service department.

Your equipment should only be operated in perfect condition. If faults occur which could harm operators or third parties, the unit should not be used until it has been fixed.

This warranty does not cover damage caused by improper use, external mechanical causes, transport damage or interference with the unit by unauthorized persons.

9 Technical data

WSM-2	Item no.:155999
Voltage*	220–240 V / 50/60 Hz
Power consumption	2.3 A
Output	500 W
W x H x D	460 x 210 x 195 mm
Weight	13.5 kg
Speed	1500 / 3000 min ⁻¹
Height of spindle	130 mm

Technical changes reserved

*Other voltages upon enquiry.

The noise level of the unit amounts to ≤ 70 dB (A).

 The technical data are subject to change without prior notice.

10 EC Conformity Certificate

in accordance with 2006/95/EG (low-voltage guidelines) and 2004/108/EG (EMV guidelines) and 2006/42/EG (machinery guidelines)

Manufacturer: W A S S E R M A N N Product description: Polishing motor
Dental-Maschinen GmbH for dental
Rudorffweg 15 - 17 applications
D-21031 Hamburg

Model: WSM-2 Item no. 155999

Applicable standards: DIN EN 61010-1
DIN EN 61000-6-3
DIN EN 61000-6-1
DIN 45635-1
DIN EN 60335-1

Hiermit wird bestätigt, dass die oben bezeichnete Maschine den genannten EG-Richtlinien entspricht. Diese Erklärung wird ungültig, falls die Maschine ohne unsere Zustimmung verändert wird.

This is to confirm that the above mentioned machine complies with the described EC rules. This declaration becomes invalid if the machine is modified without our approval.

Cette machine est conforme aux normes en vigueur de la Communauté Européene. Cet avis est nul et non avenant si cette machine est modifiée sans notre accord.

Esta máquina, anteriormente mencionada, cumple con los límites requeridos por el reglamento EC. Ahora bien, esta declaración quedará invalidada en caso de realizar modificaciones al aparato sin nuestra aprobación.

Hiermee wordt bevestigd dat bovengenoemde machine voldoet aan de voorgeschreven EU normen. Deze verklaring verliest geldigheid als er zonder onze uitdrukkelijke toestemming wijzigen aan de machine worden aangebracht.

Place, date: Hamburg, 07.09.2012

Company stamp:



Signature : _____

Wilfried Wassermann
(Managing Director)

11 Spare part diagram

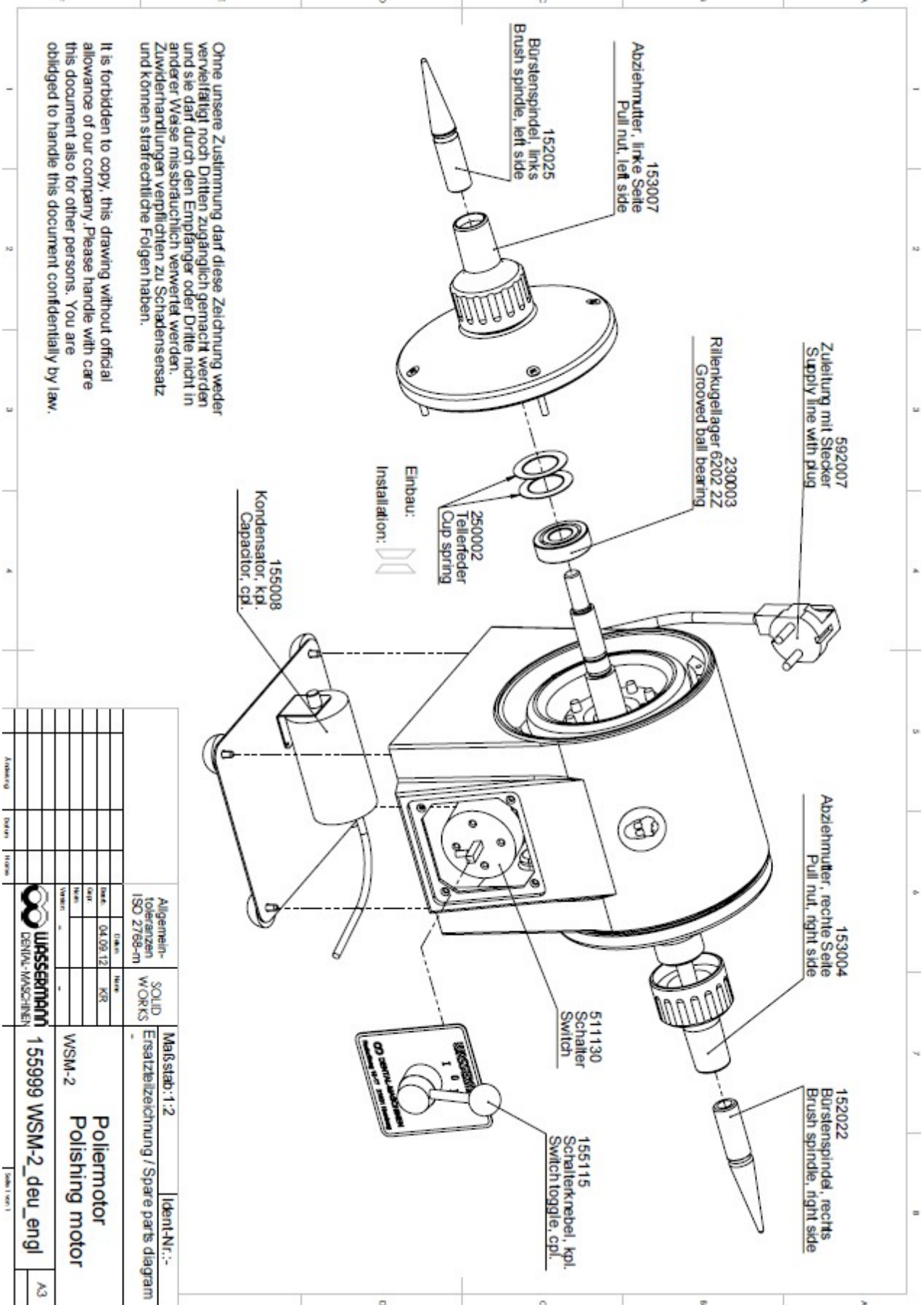

Ohne unsere Zustimmung darf diese Zeichnung weder vervielfältigt noch Dritten zugänglich gemacht werden und sie darf durch den Empfänger oder Dritte nicht in anderer Weise missbräuchlich verwendet werden. Zuwiderhandlungen verpflichten zu Schadensersatz und können strafrechtliche Folgen haben.

It is forbidden to copy, this drawing without official allowance of our company. Please handle with care this document also for other persons. You are obliged to handle this document confidentially by law.

Allgemein- kennzeichen ISO 21768-M		SOLID WORKS	Ident-Nr.:-
Typ	04.09.12	KQR	
WSM-2			
Poliermotor Polishing motor			
1 55999 WSM-2_deu_engl			
A3			

12 Wiring diagram

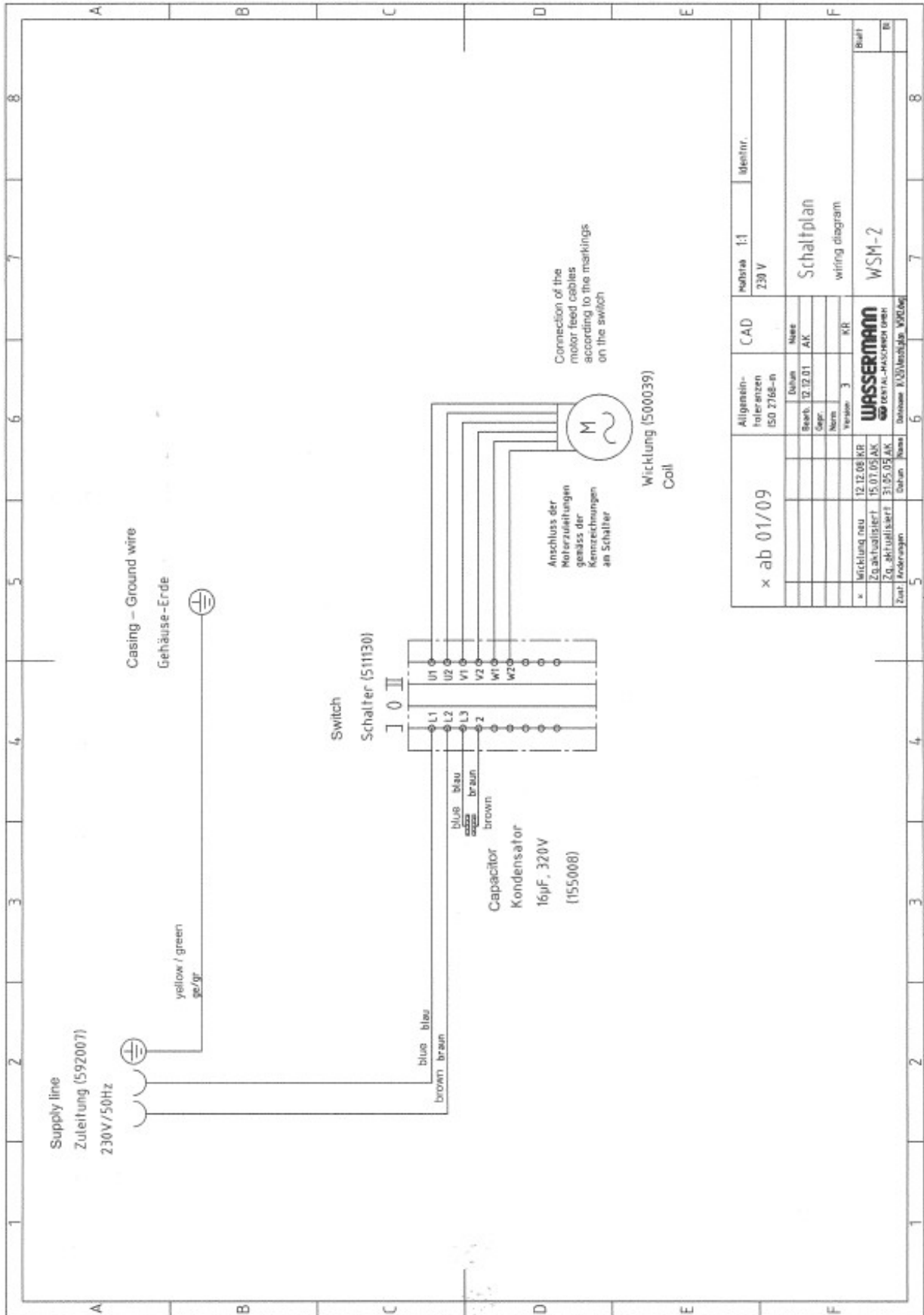



WASSERMANN
DENTAL-MASCHINEN

● Die Basis für Ihr Labor

Wassermann Dental-Maschinen GmbH
Rudorffweg 15-17 · D-21031 Hamburg
Tel.: +49 (0)40 730 926-0 · Fax: +49 (0)40 730 37 24
info@wassermann-dental.com

www.wassermann-dental.com